

PROJECT: _____
 TYPE: _____
 PRODUCT: _____
 APPROVED BY: _____



CCSLR-VI



CCSLR-HI

PRODUCT FEATURES

- Field-adjustable LED CCT: Amber (585nm-595nm), White (2700K-5000K), Blue (469nm-480nm), or Red (620nm-630nm)
- 90-degree cut-off obstructs light trespass
- Built for durability; diecast faceplate with polycarbonate lens
- Selectable Sensor with settings for Photo/Motion/Off (can be turned on or off during installation)
- 0-10V Dim adjusted light level
- Installs to a standard J-Box (by others)
- IK10 listed per IEC60068, IP64 rated per IEC60598, NSF2 Splash/Non-Food Zone listed
- This product complies with the Buy American Act (BAA) when specifying "HG" under lumen output

ORDERING INFORMATION

Example: CCSLR-VI-SD-CCT-LIC-UN-TWB



* Must specify "HG" for compliance.

CCSLR			
Series	Faceplate Style VI = Vertical VI HI = Horizontal HI	Lumen Output SD = Standard Output (17 Lumens) HG = High Output (34 Lumens)* *N/A with CCT2. Must specify for BAA Compliance.	Color Temperature* CCT = White LED 2700K-5000K CCT2 = Amber / Red /Blue *Housing comes in either white field selectable CCT options or color (amber, red or blue) field selectable options

UN		
Finish* blank = Standard White ALM = Almond (RAL 9001) BLK = Black BL = Blue (RAL 5009) LB = Light Blue (RAL 6034) LG = Light Gray (RAL 7035) LIC = Lilac (RAL 4009) PG = Pistachio Green CC = Custom RAL Color *Antimicrobial finishes are is standard. Color swatches on Page 3.	Voltage UN = Universal (120V-277V)	Accessories TWB = Adjustable thru-wall box with hangers (requires two steplights per thru-wall junction box)



New Star Lighting

2225 W Pershing Rd, Chicago, IL 60609
 (773) 847-1400
 www.newstarlighting.com

Specifications and dimensions are subject to change without notice. For additional options and dimensional details, please consult your New Star Lighting representative.
 © 2026, New Star Lighting. All rights reserved. Unauthorized duplication or distribution is prohibited.

SPECIFICATIONS

CONSTRUCTION: ADA-compliant. Ligature-resistant, diecast aluminum faceplate and reflector.

LENS: UV-Stabilized, injection-molded polycarbonate.

LED: Available in field-selectable White LEDs (2700K-5000k) at 80 CRI, or field-selectable colors: Amber (585-595nm), Red (620-630nm), Blue (469-480nm). Minimum 30,000h with 70% of lumen maintenance in 25°C ambient temperature environment, in compliance with IES LM-70 testing measurements.

ELECTRICAL: 120-277VAC, 50-60HZ, input wattage ~1W, power factor >0.9. L 0-10V Dimming.

PHOTO CONTROL OPTION: Control circuit can be pre-set with four sensing modes: ON, Photo sensing (PS), PIR sensing, PIR + PS sensing. Delay time for PIR and PIR+PS modes is 1 minute (if no movement, then auto shut off after 1 minute). Environment light sensing: <80 lux LED ON & >300 lux LED OFF.

FINISH: Antimicrobial polyester powder coat finish following multi-stage iron phosphate pre-treatment. Black and other custom finishes optional.

INSTALLATION: Backplate installs to a single-gang j-box (by others). Thru-wall accessory housing also available for shared walls.

LABEL: IK10 listed per IEC60068, IP64 rated per IEC60598, NSF2 Splash/Non-Food Zone listed. This product complies with the Buy American Act (BAA) when specifying "HG" under lumen output.

DIMENSIONAL DATA

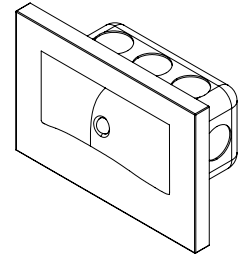
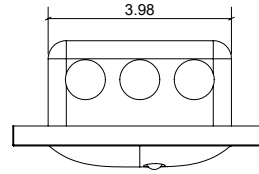

Horizontal (HO)

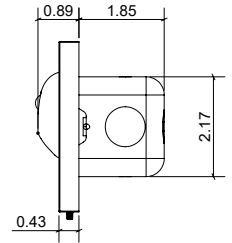
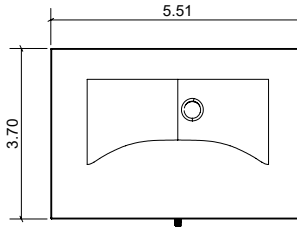

Vertical (VO)

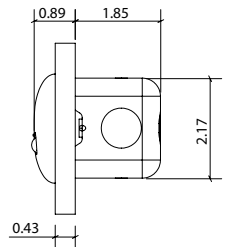
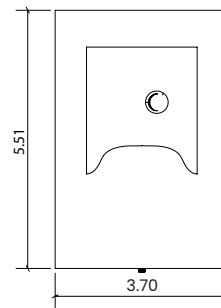

ACCESSORIES (OPT.)

Thru-wall Option

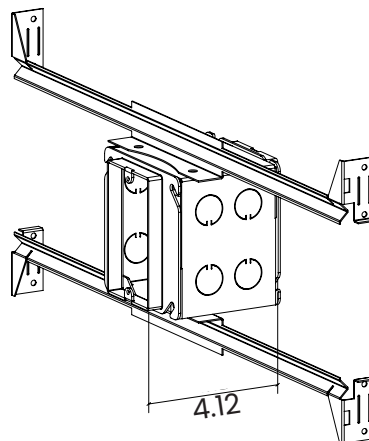

New Star Lighting

2225 W Pershing Rd, Chicago, IL 60609
(773) 847-1400
www.newstarlighting.com

Specifications and dimensions are subject to change without notice. For additional options and dimensional details, please consult your New Star Lighting representative.

© 2026, New Star Lighting. All rights reserved. Unauthorized duplication or distribution is prohibited.

ANTIMICROBIAL FINISHES

Almond (RAL 9001)
(ALM)

Blue (RAL 5005)
(BL)

Light Blue (RAL 5024)
(LB)

White
(blank)



Light Gray (RAL 7035)
(LG)

Lilac (RAL 4009)
(LIC)

Pistachio Green
(PG)

Black
(BLK)



PERFORMANCE DATA

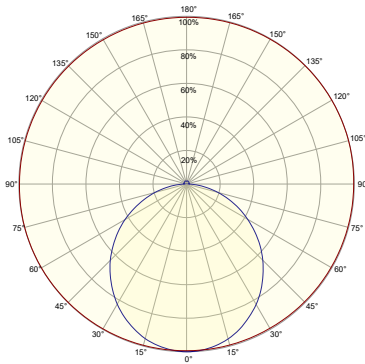

Maximum intensity = 272.0 cd. Located at horizontal, vertical angles 15H 5V

- Peak plane: C165 - C345 (through max.intensity cd)
- Horizontal cone through vertical angle 5



New Star Lighting

2225 W Pershing Rd, Chicago, IL 60609
(773) 847-1400
www.newstarlighting.com

Specifications and dimensions are subject to change without notice. For additional options and dimensional details, please consult your New Star Lighting representative.
© 2026, New Star Lighting. All rights reserved. Unauthorized duplication or distribution is prohibited.